

1

2

3

4

5

6

7

8

9

10

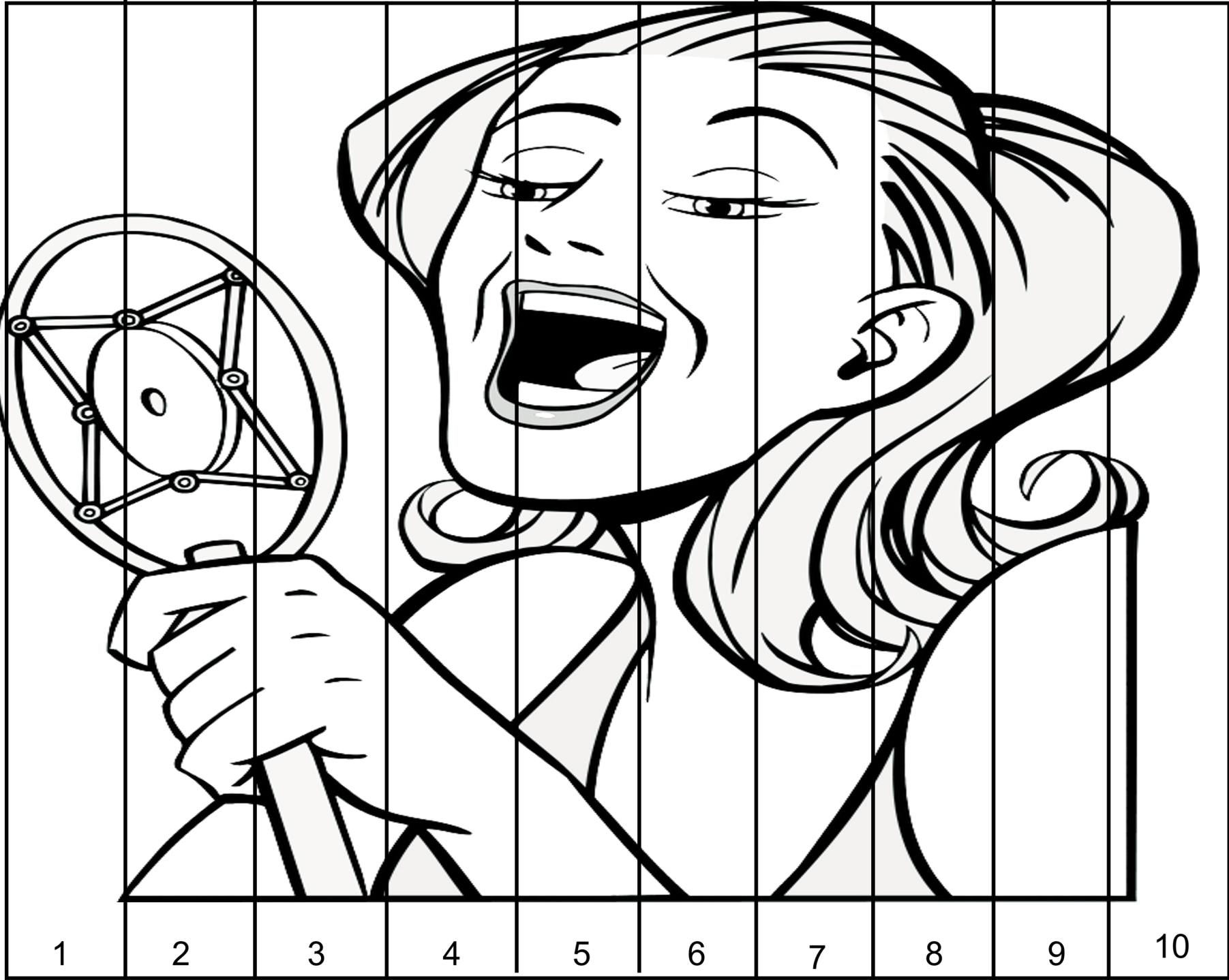

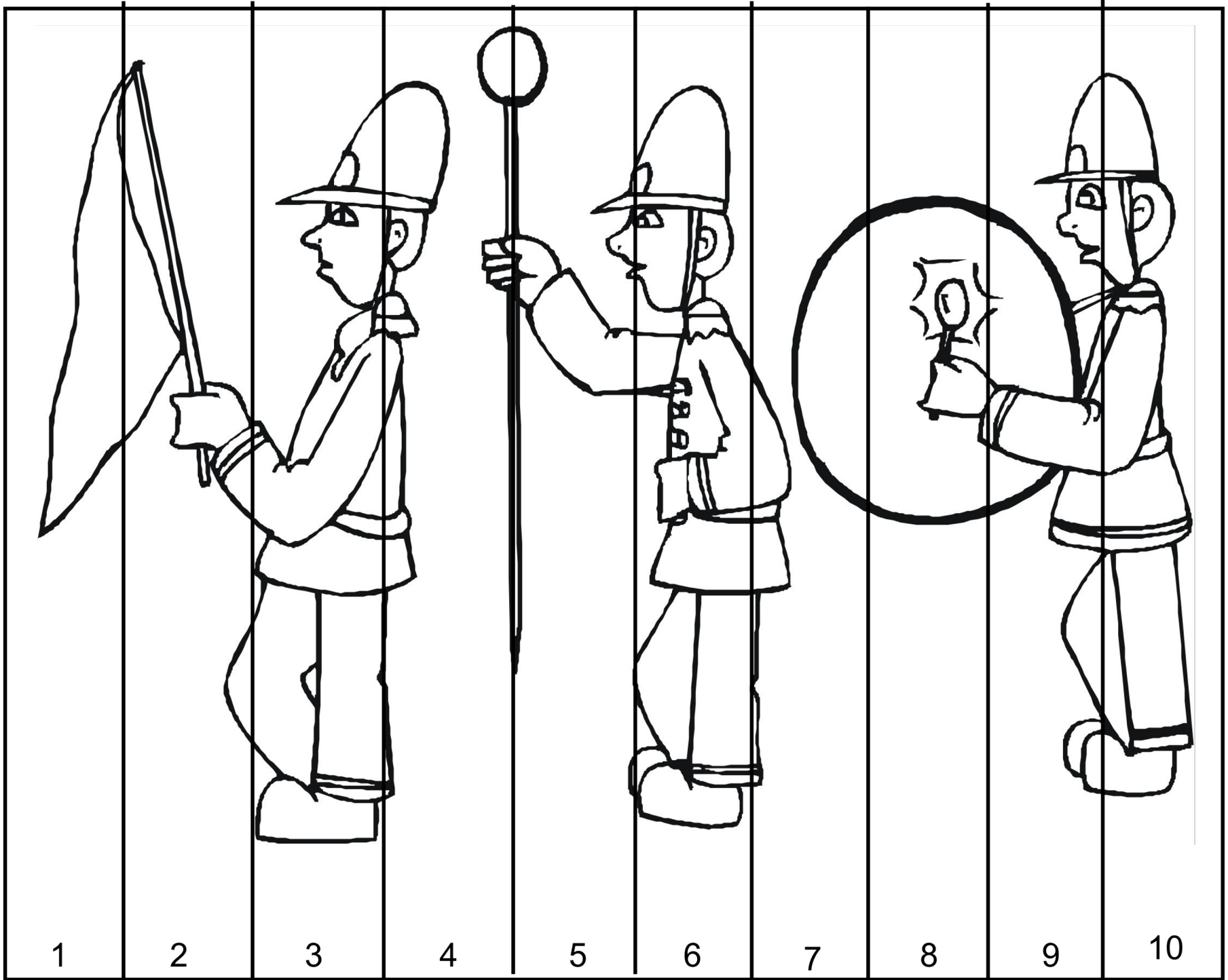

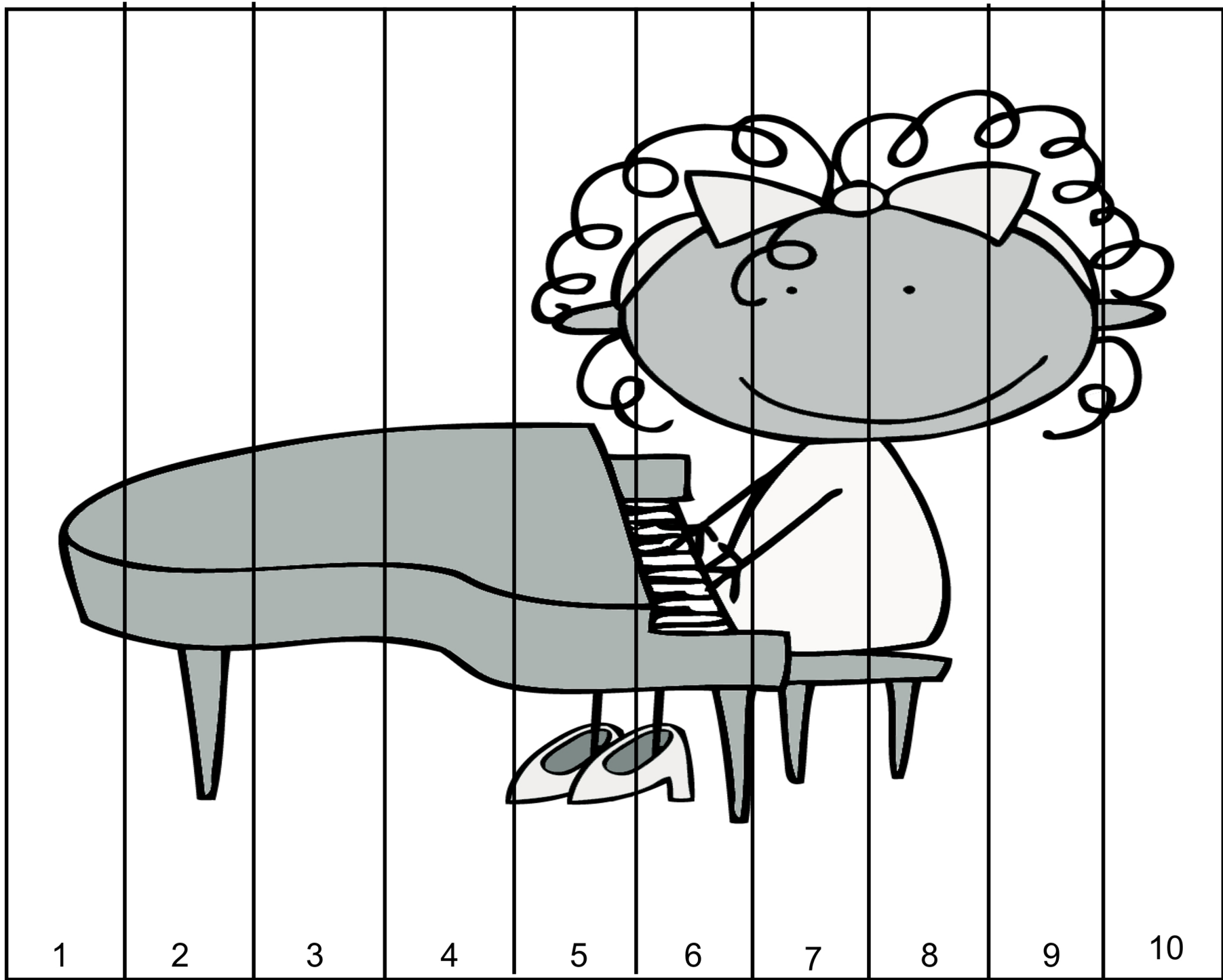

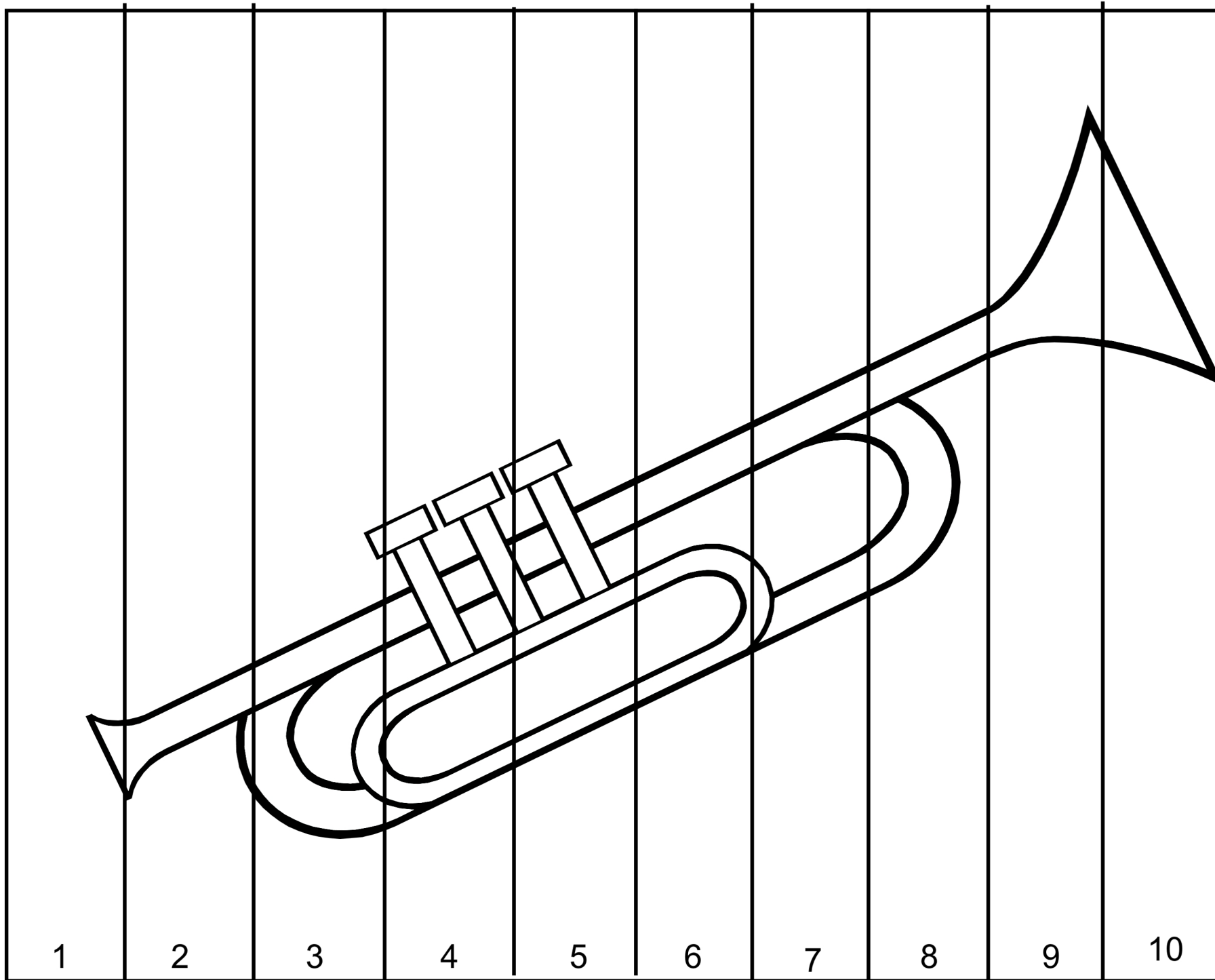

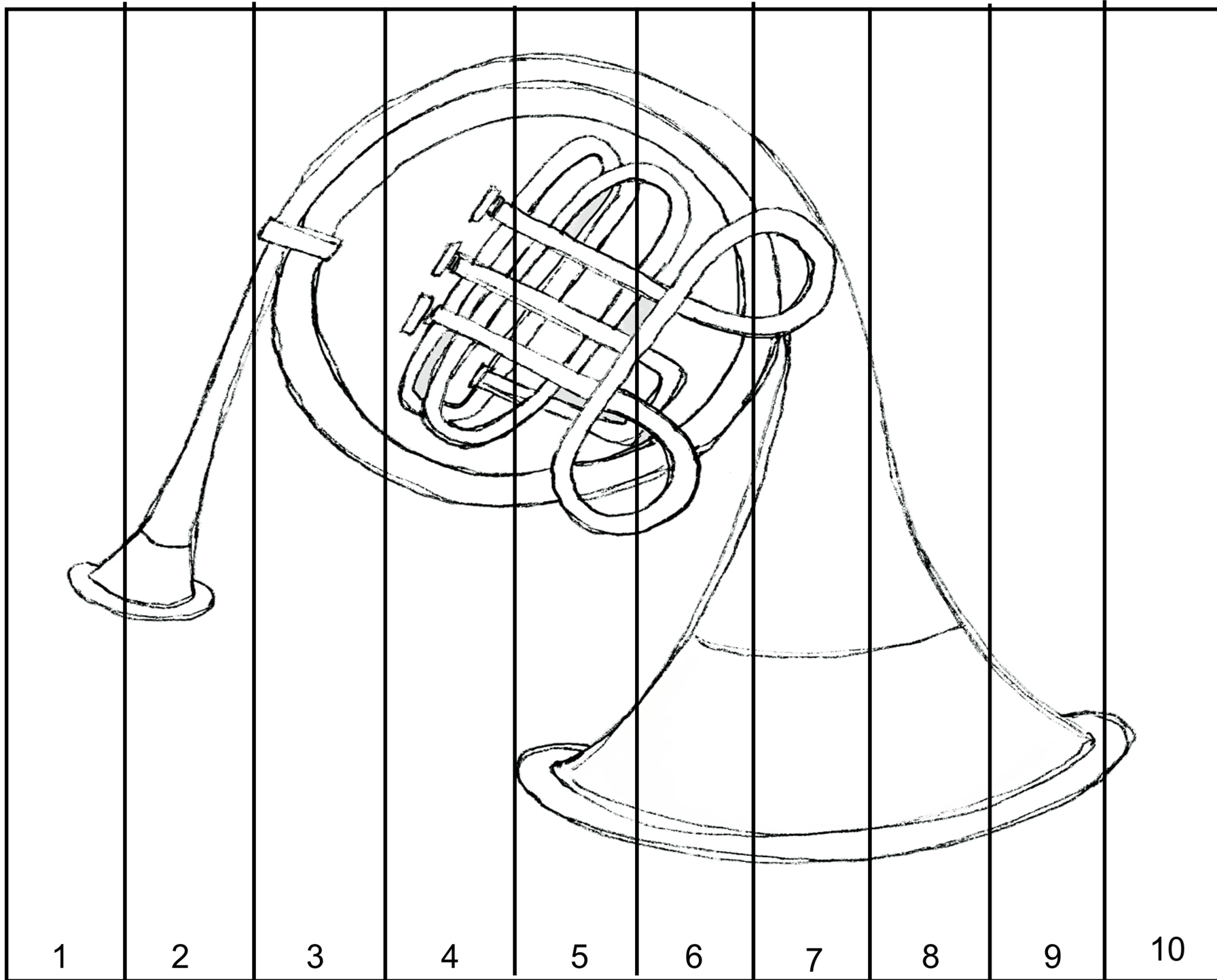

1

2

3

4

5

6

7

8

9

10

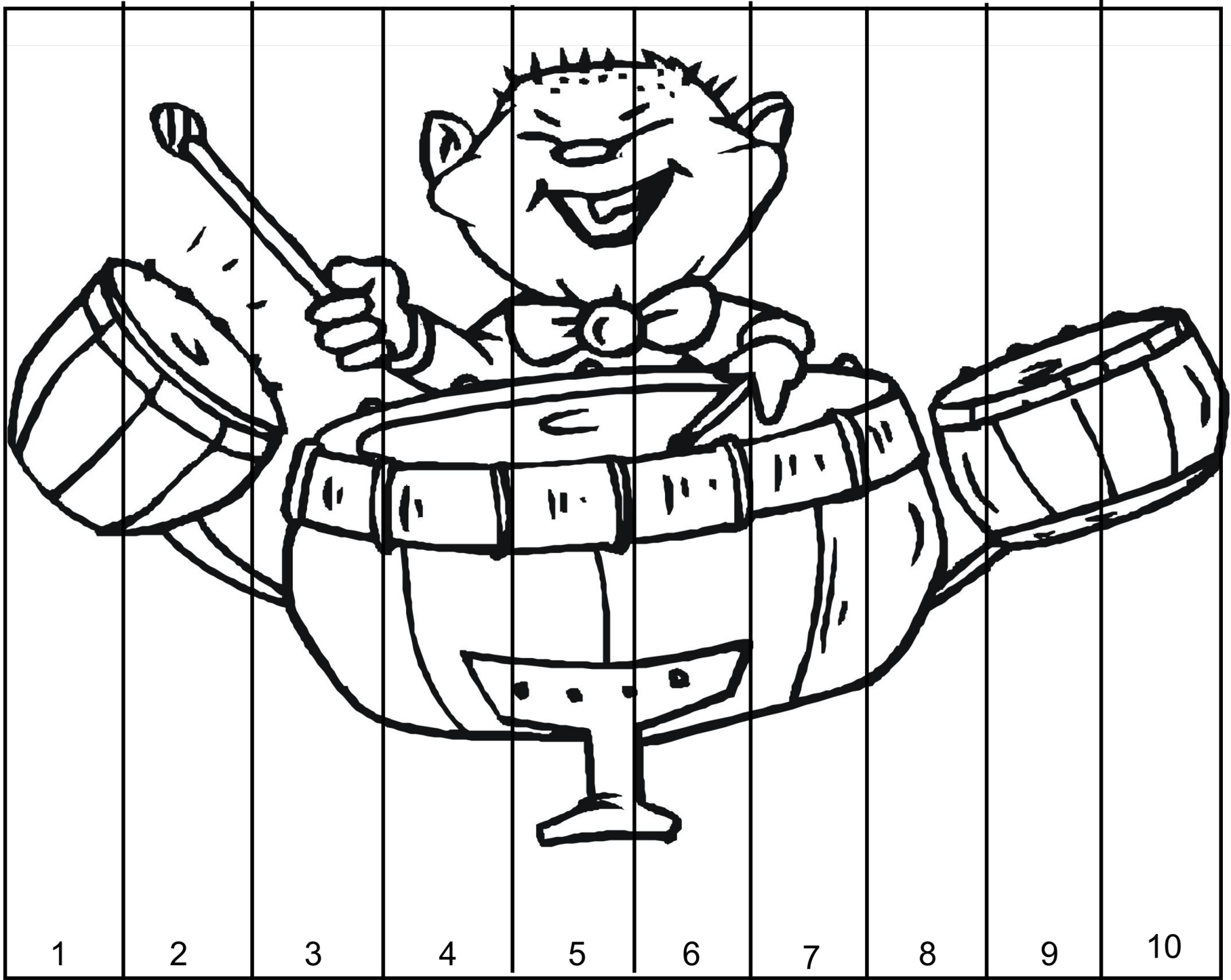

1

2

3

4

5

6

7

8

9

10





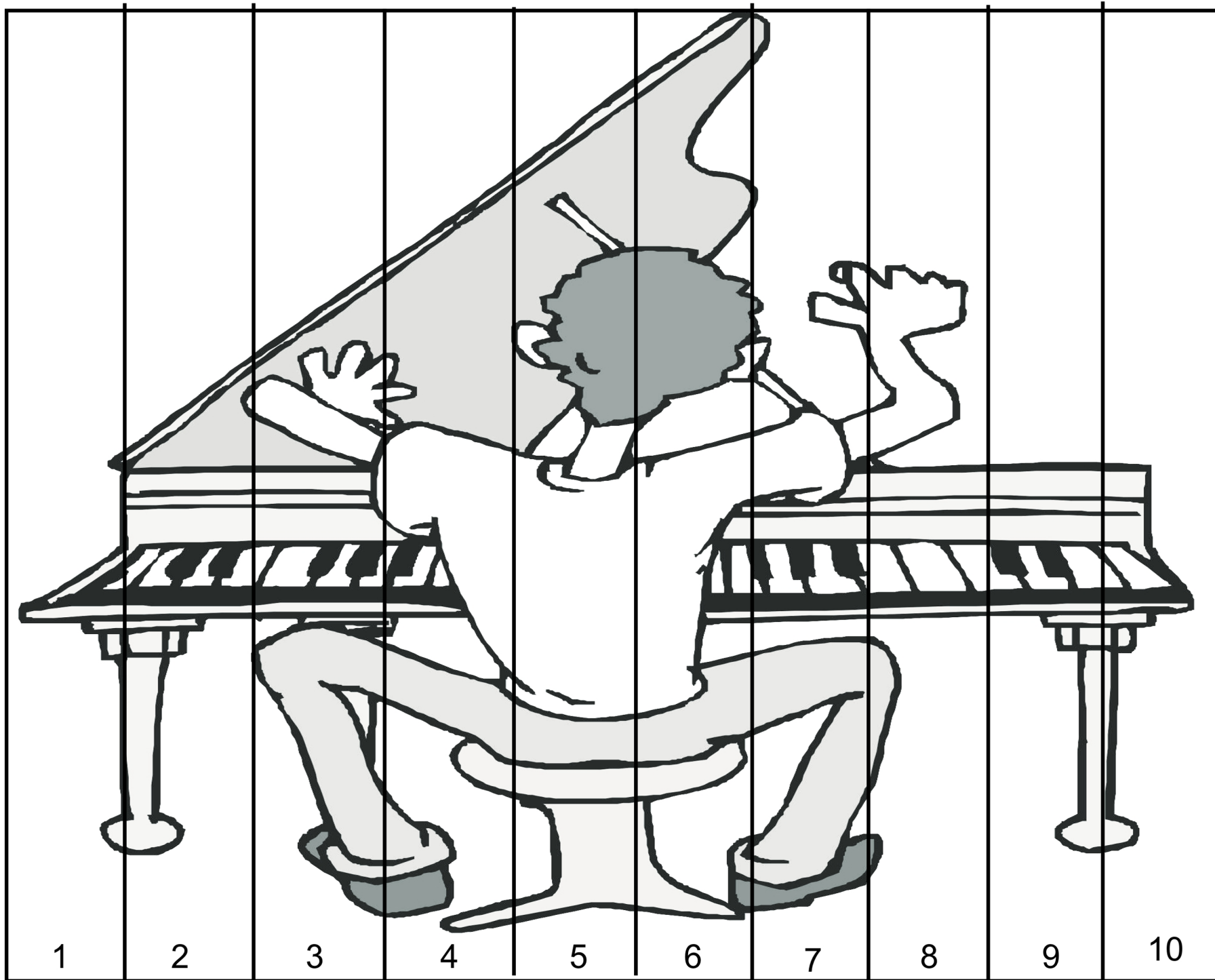

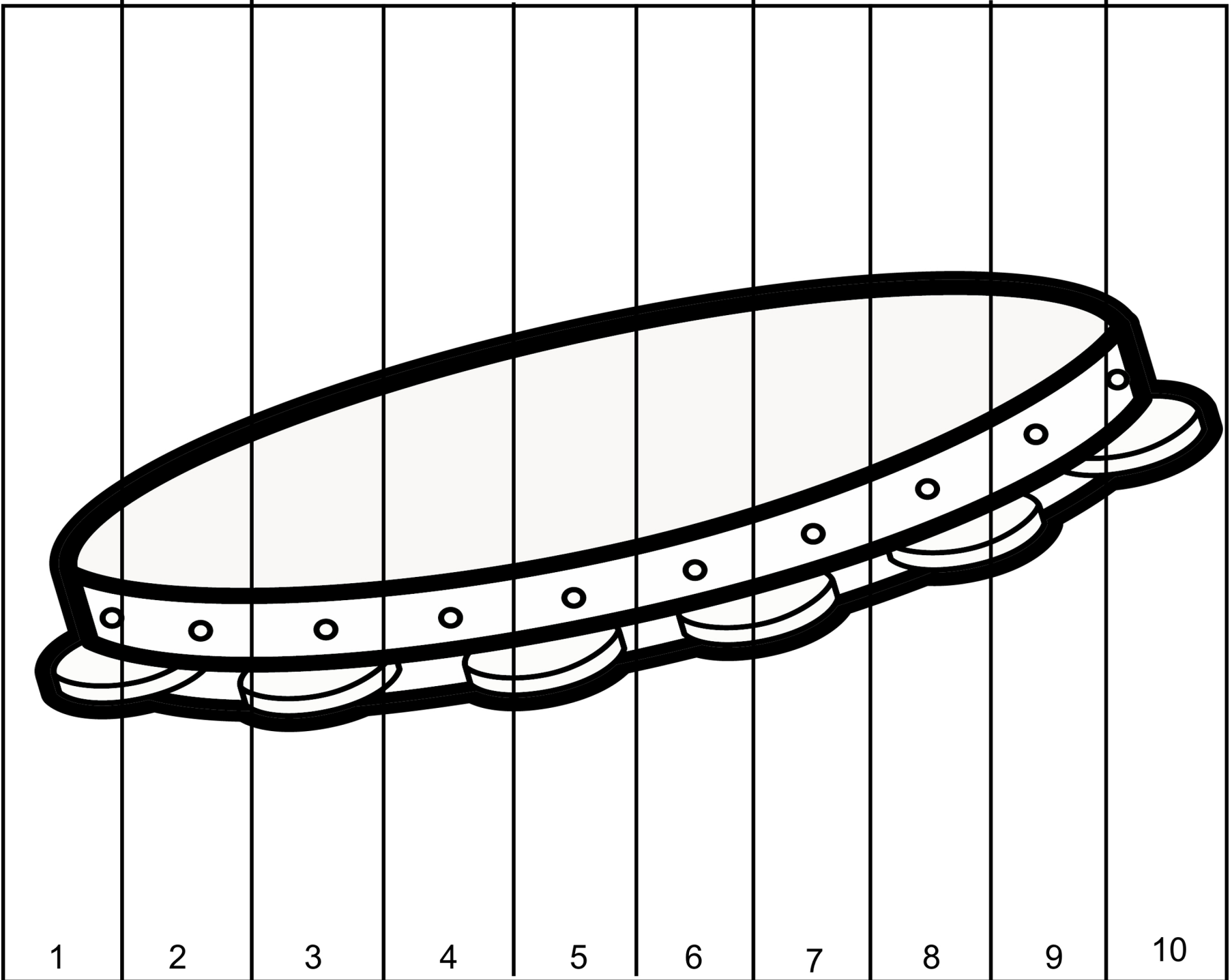

1

2

3

4

5

6

7

8

9

10

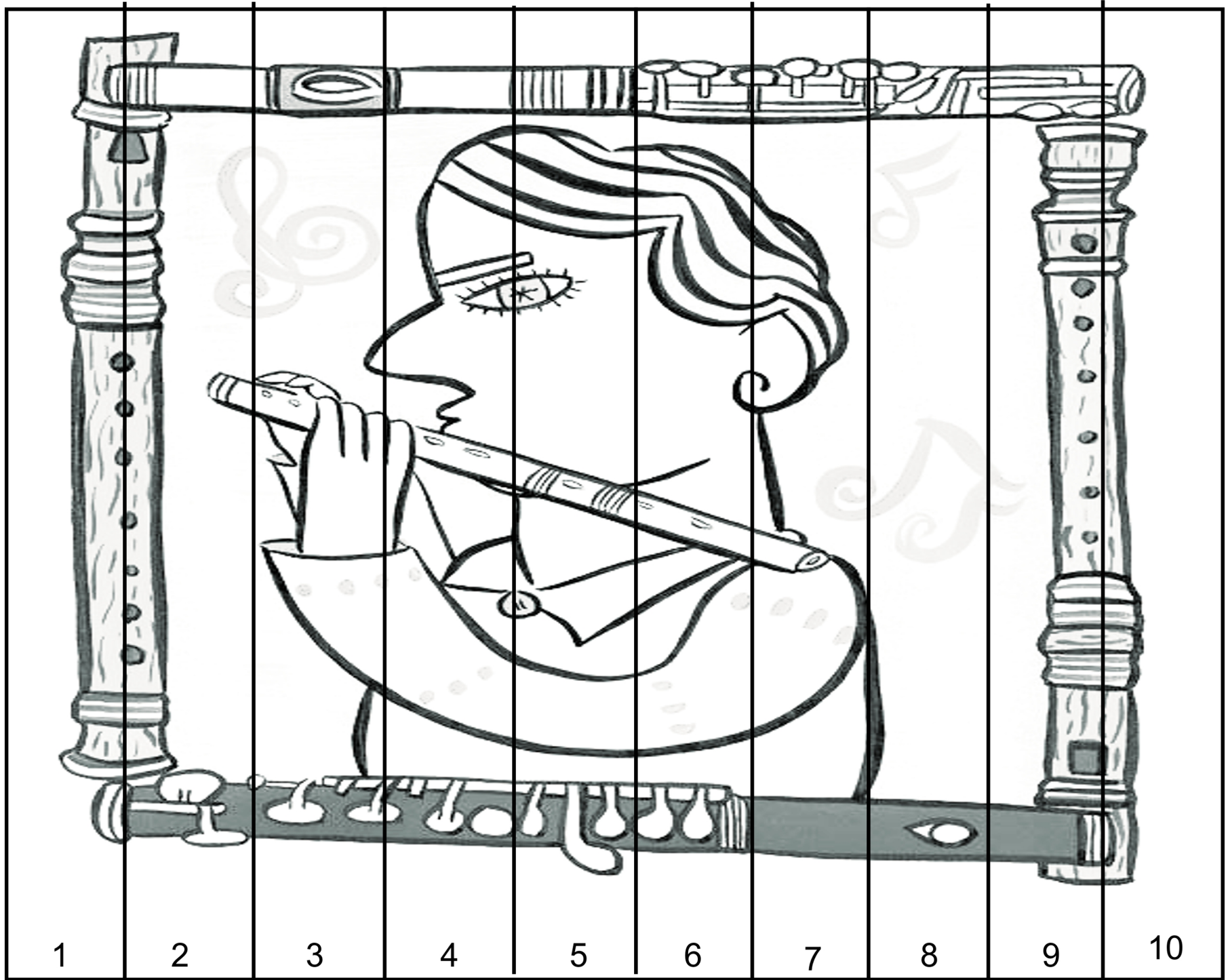

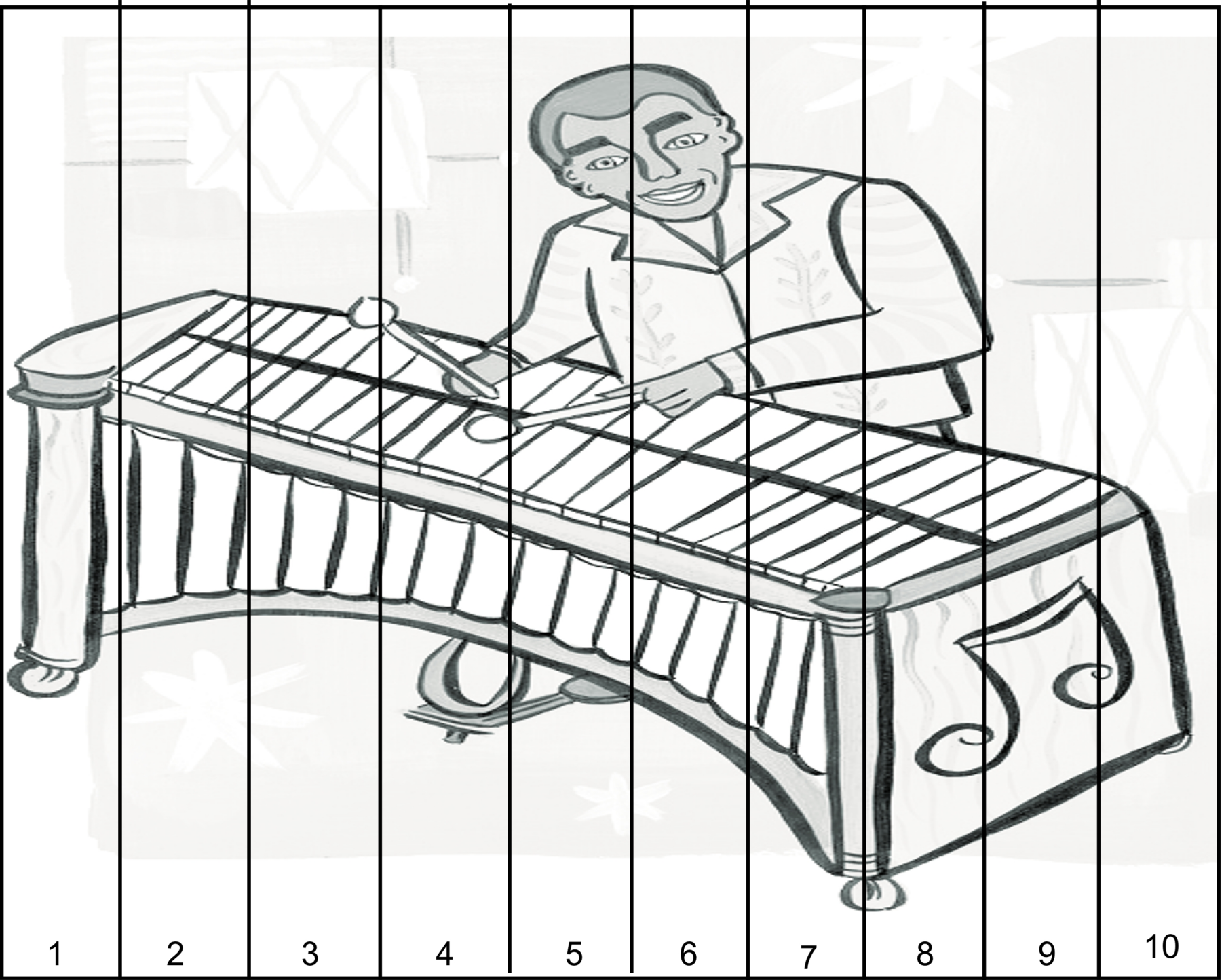

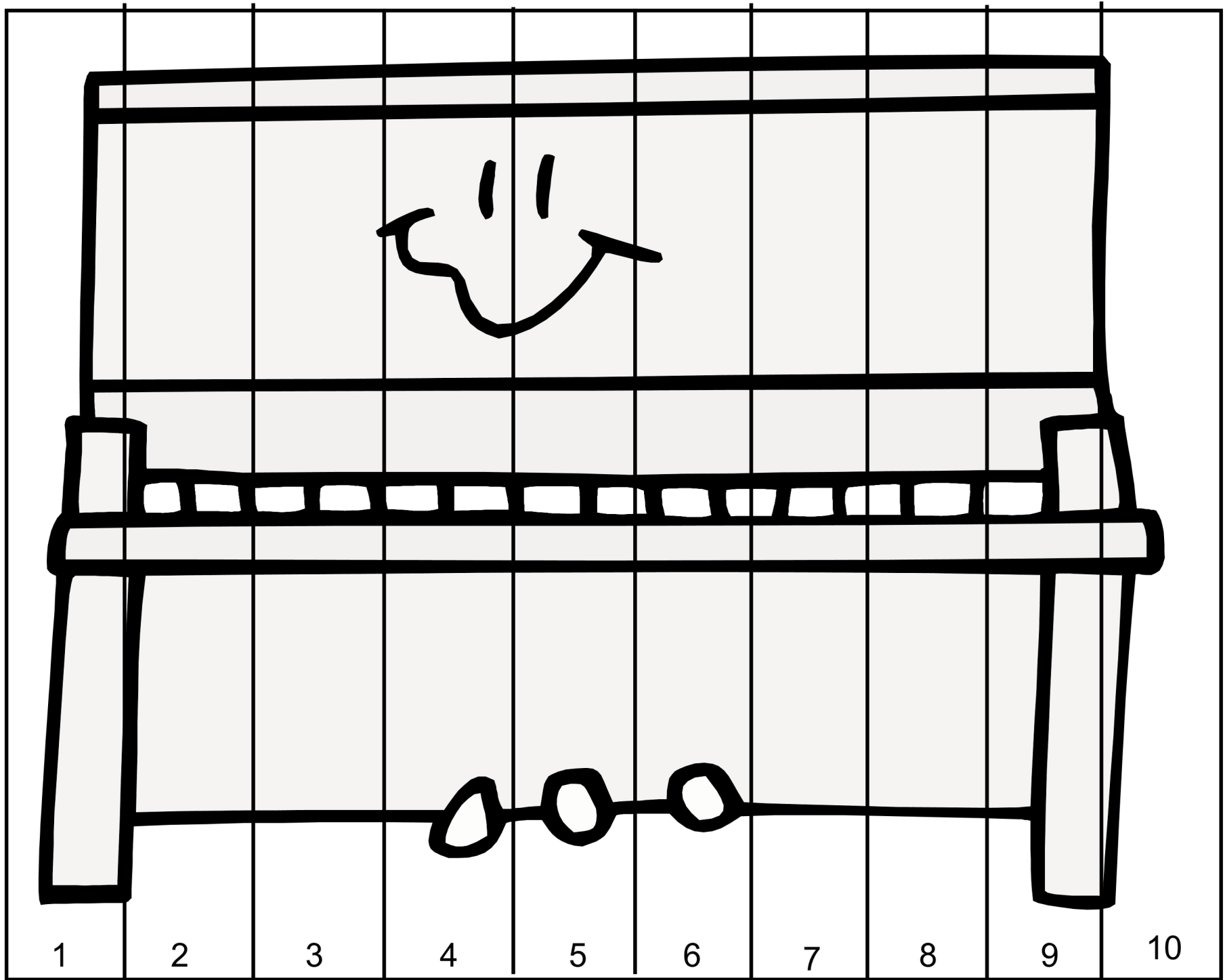

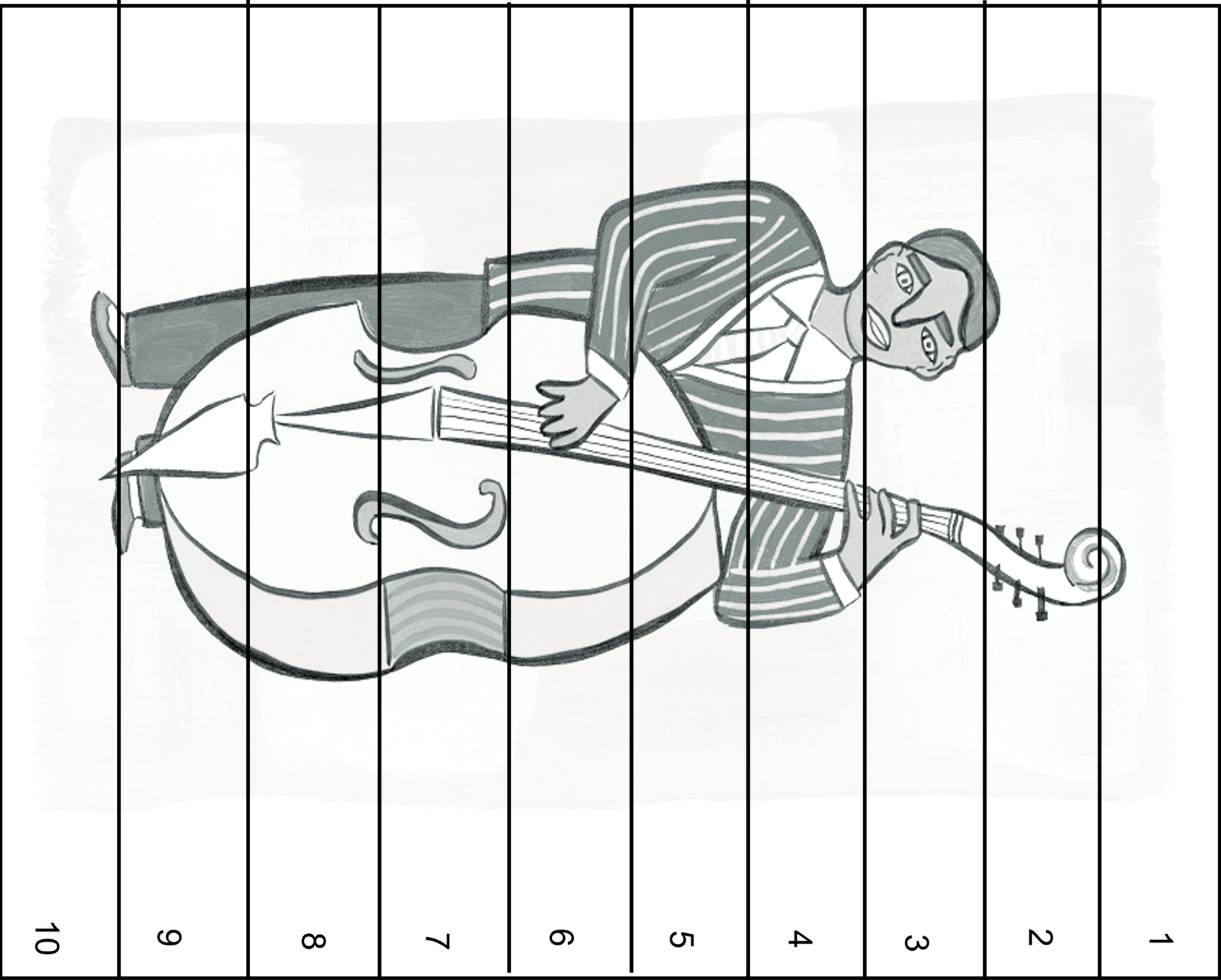

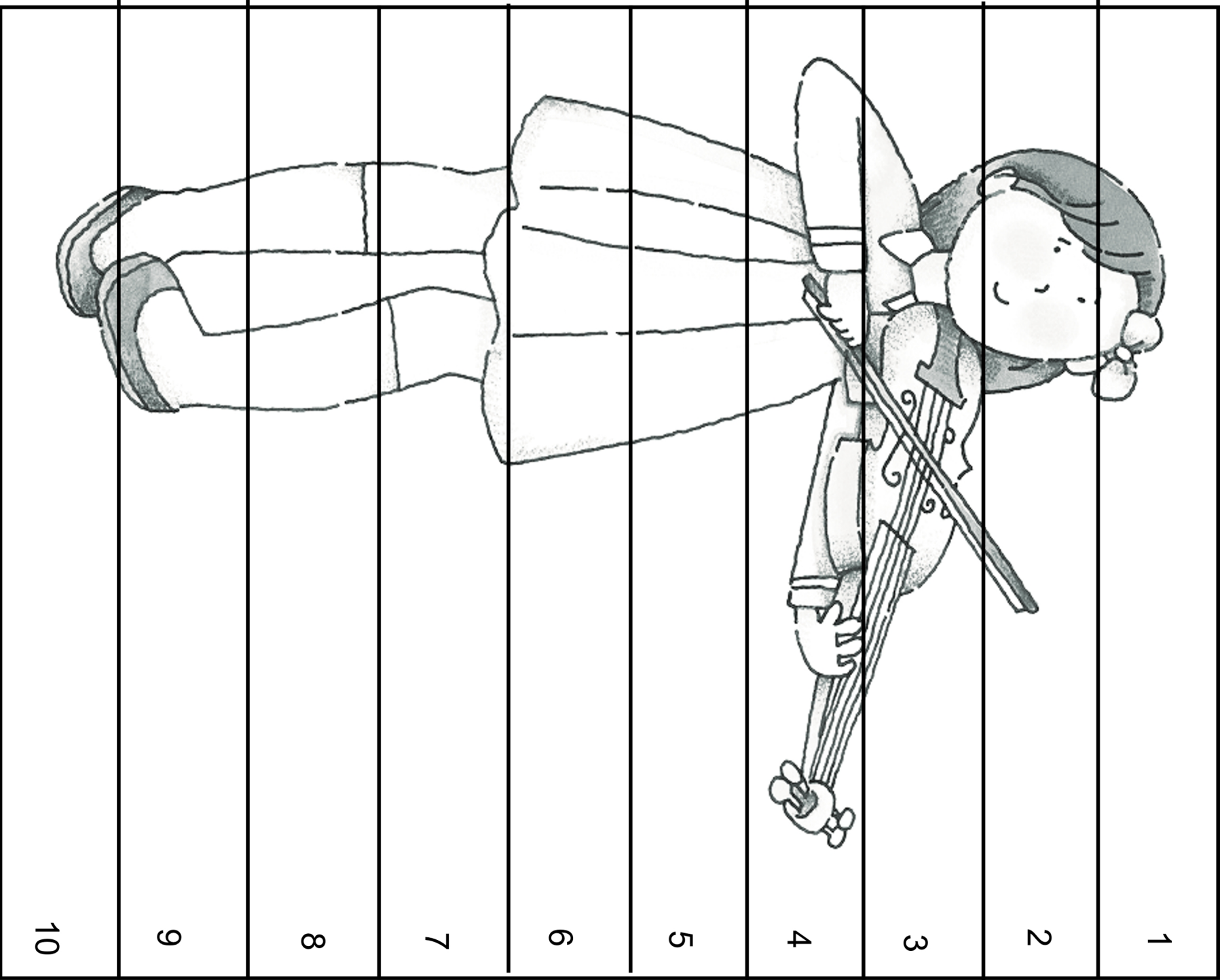

1

2

3

4

5

6

7

8

9

10



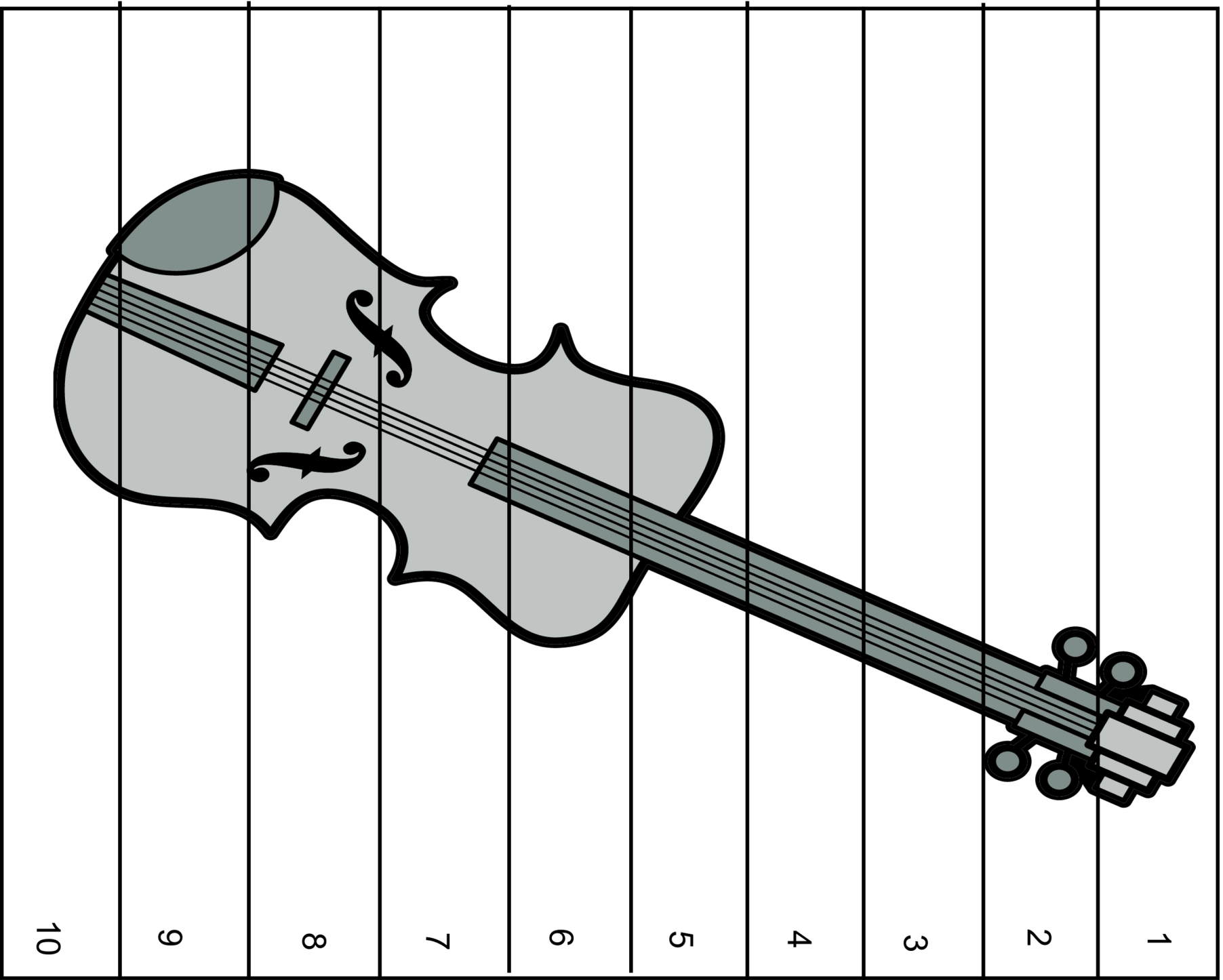

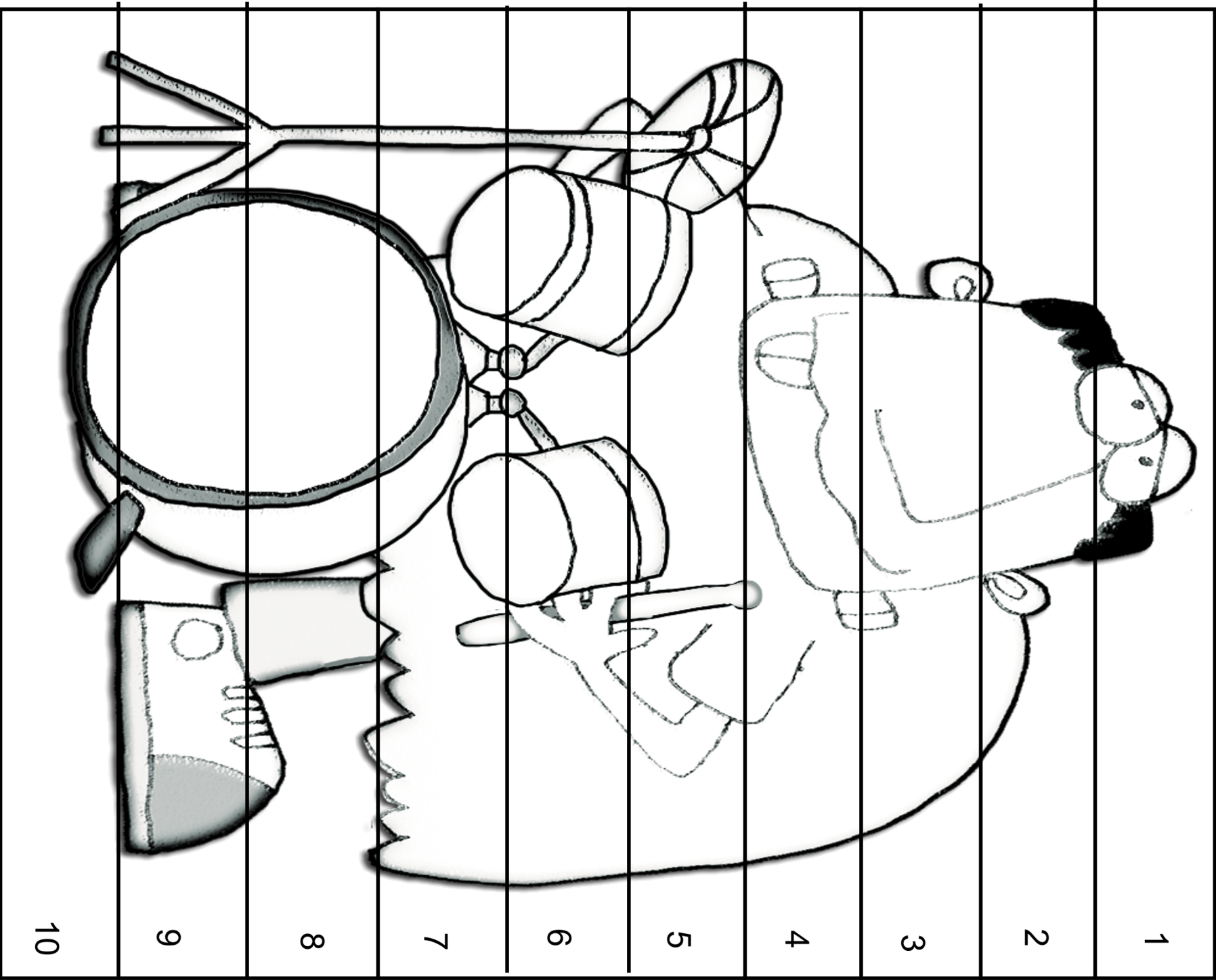

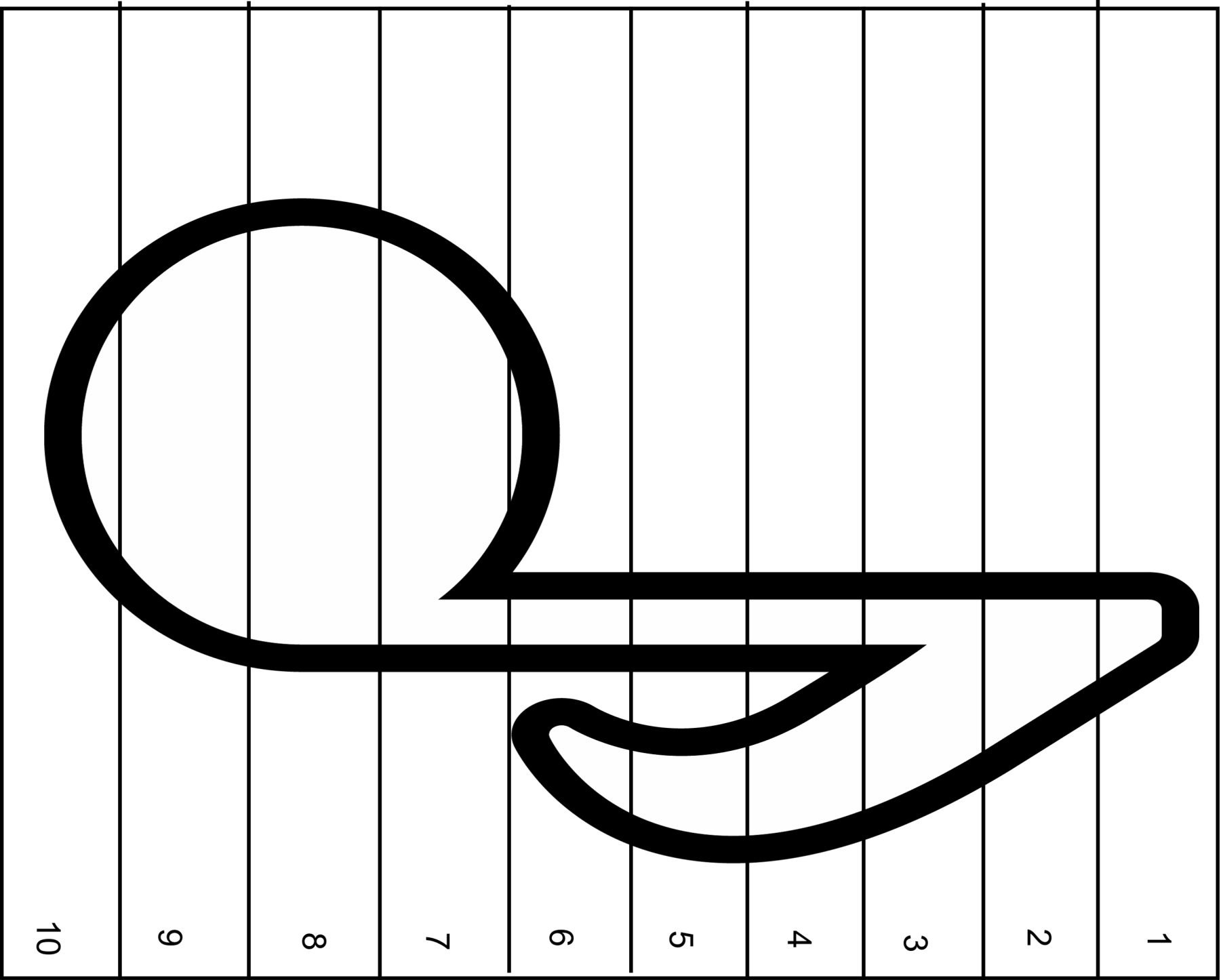

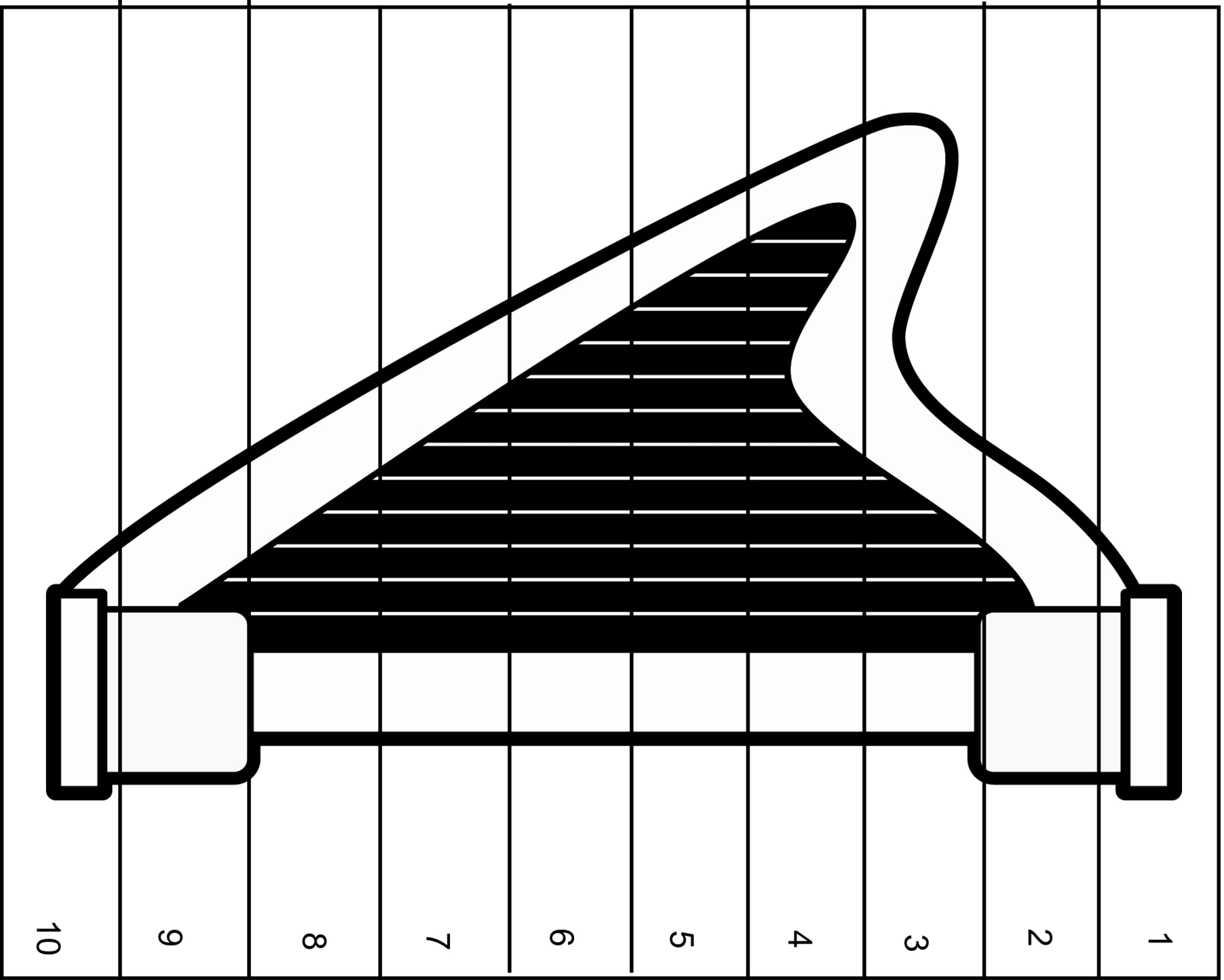

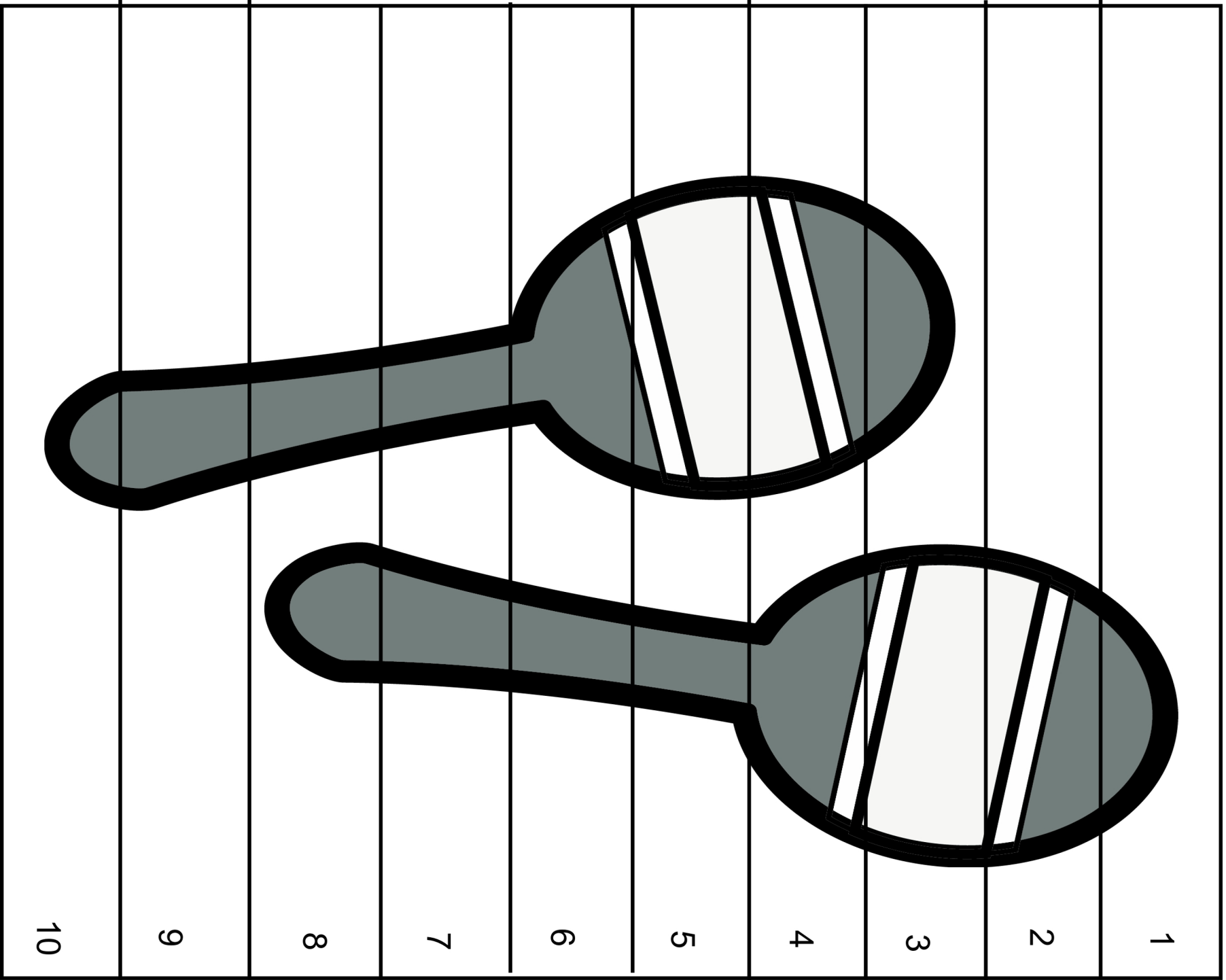

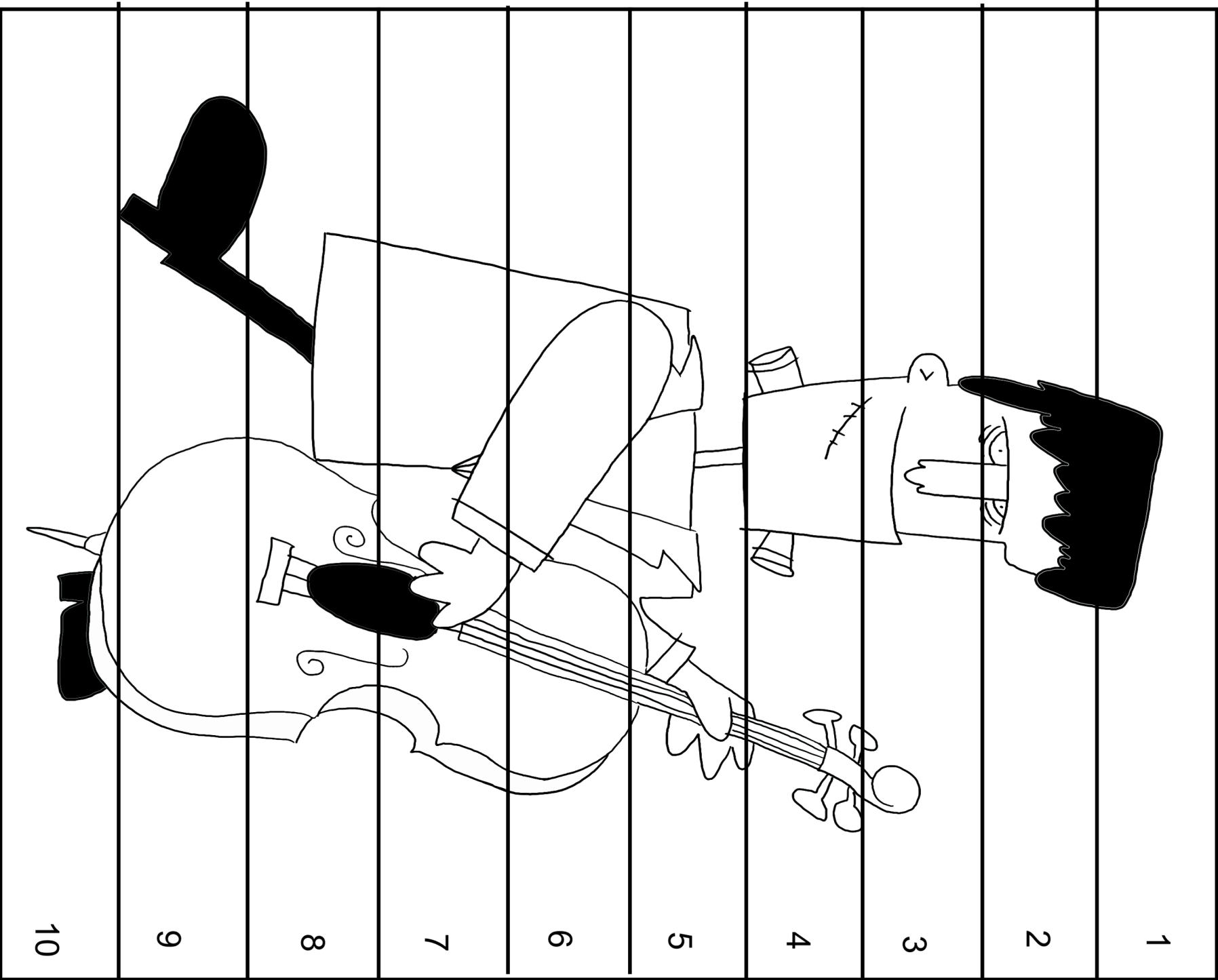

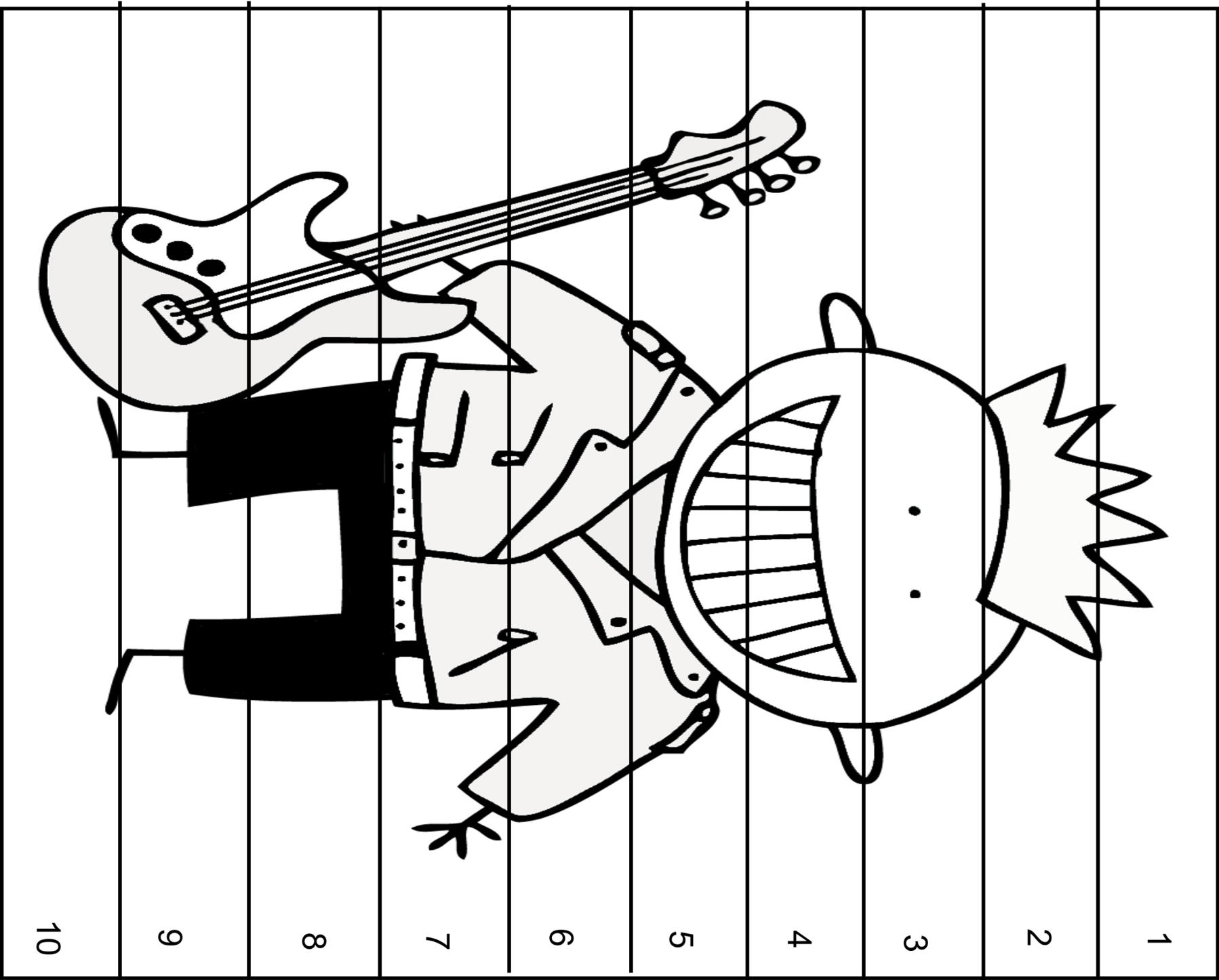

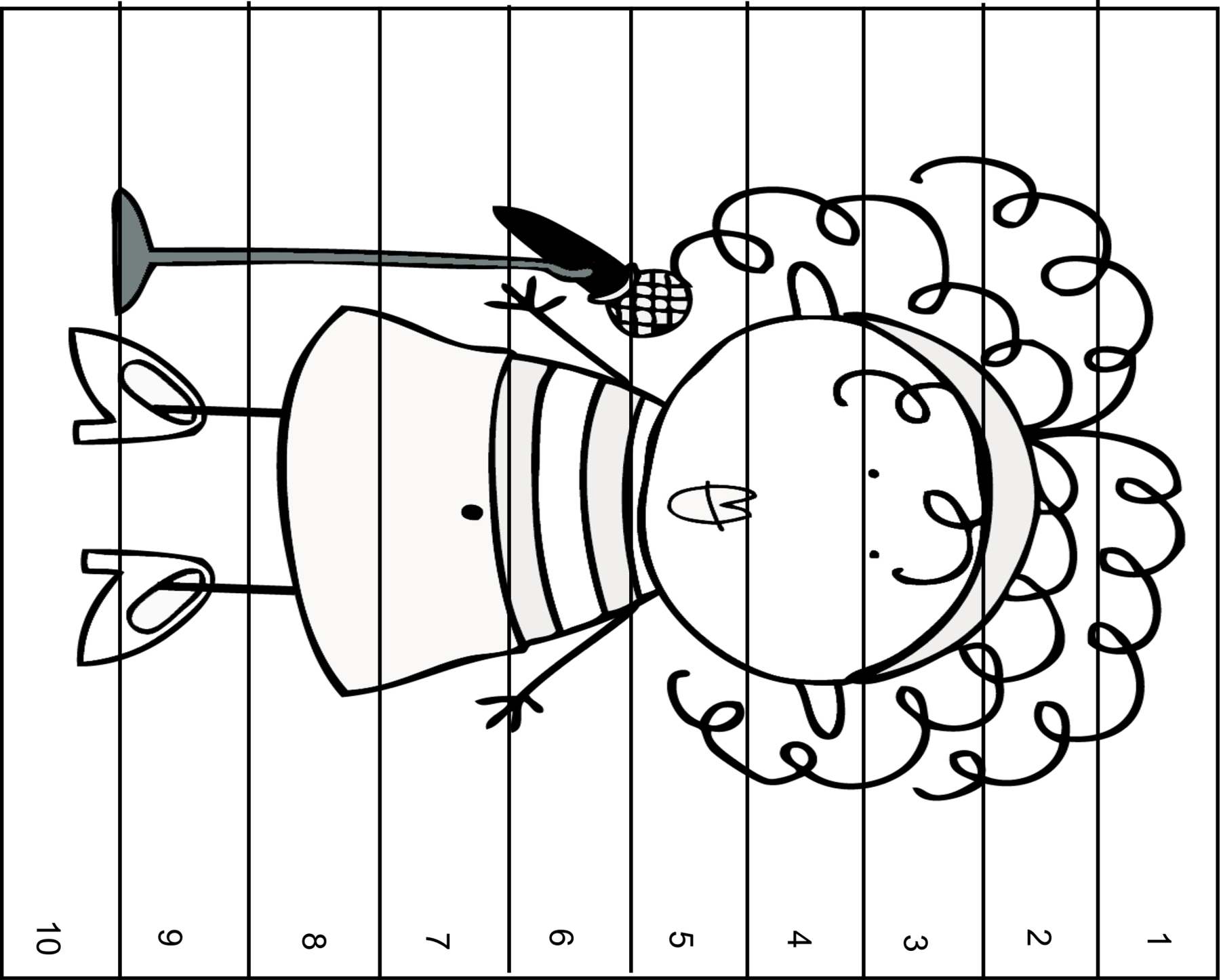

1

2

3

4

5

6

7

8

9

10



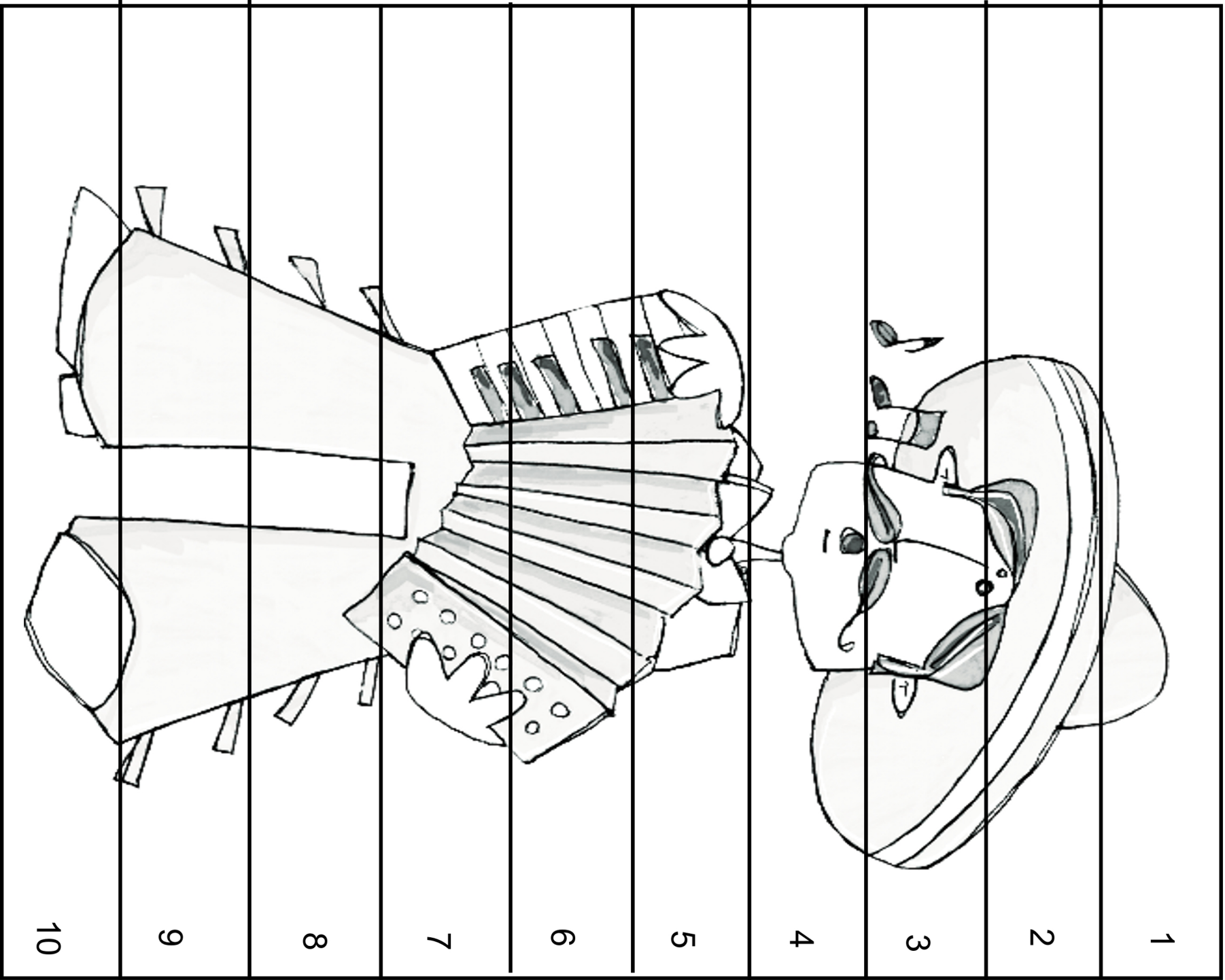

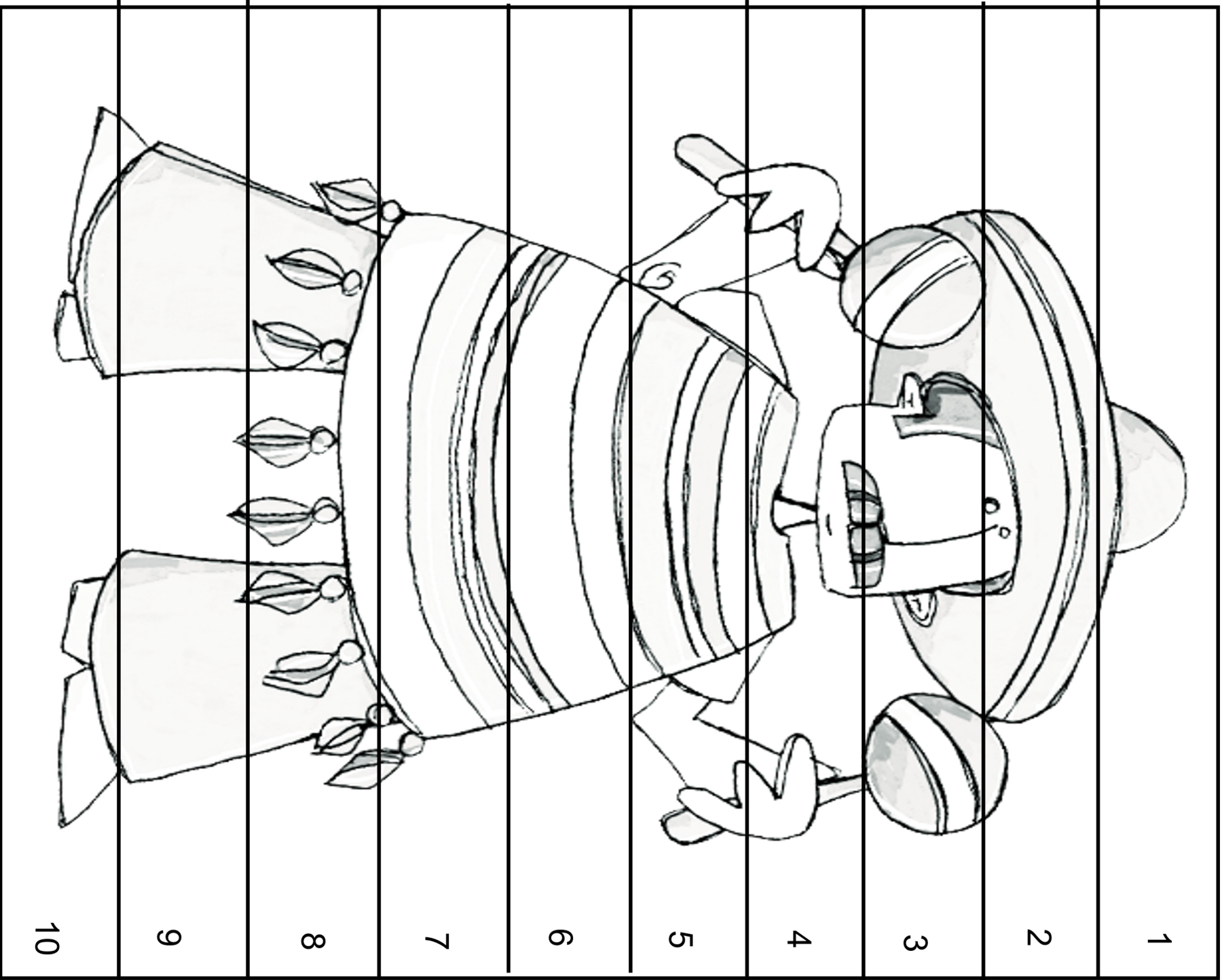

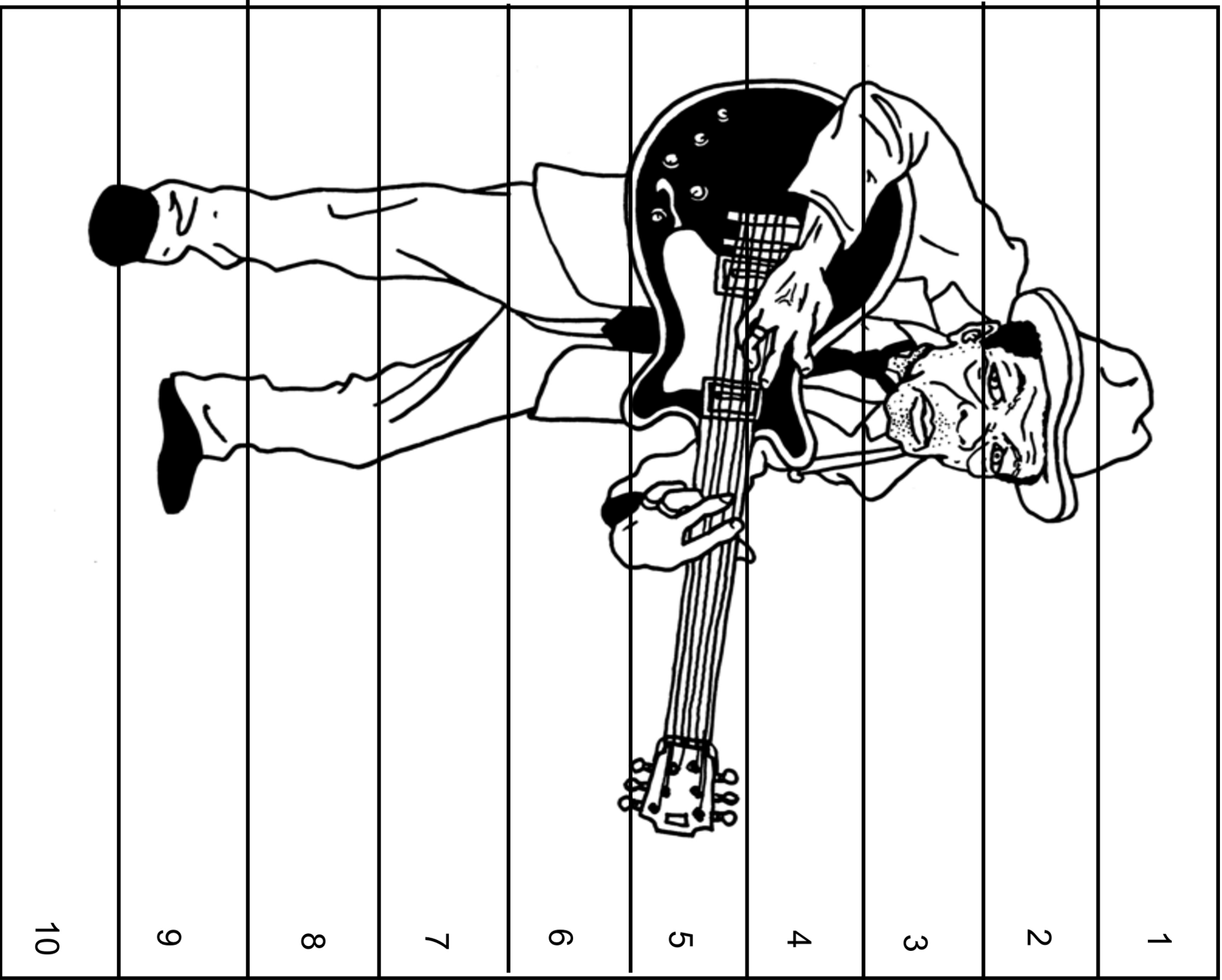

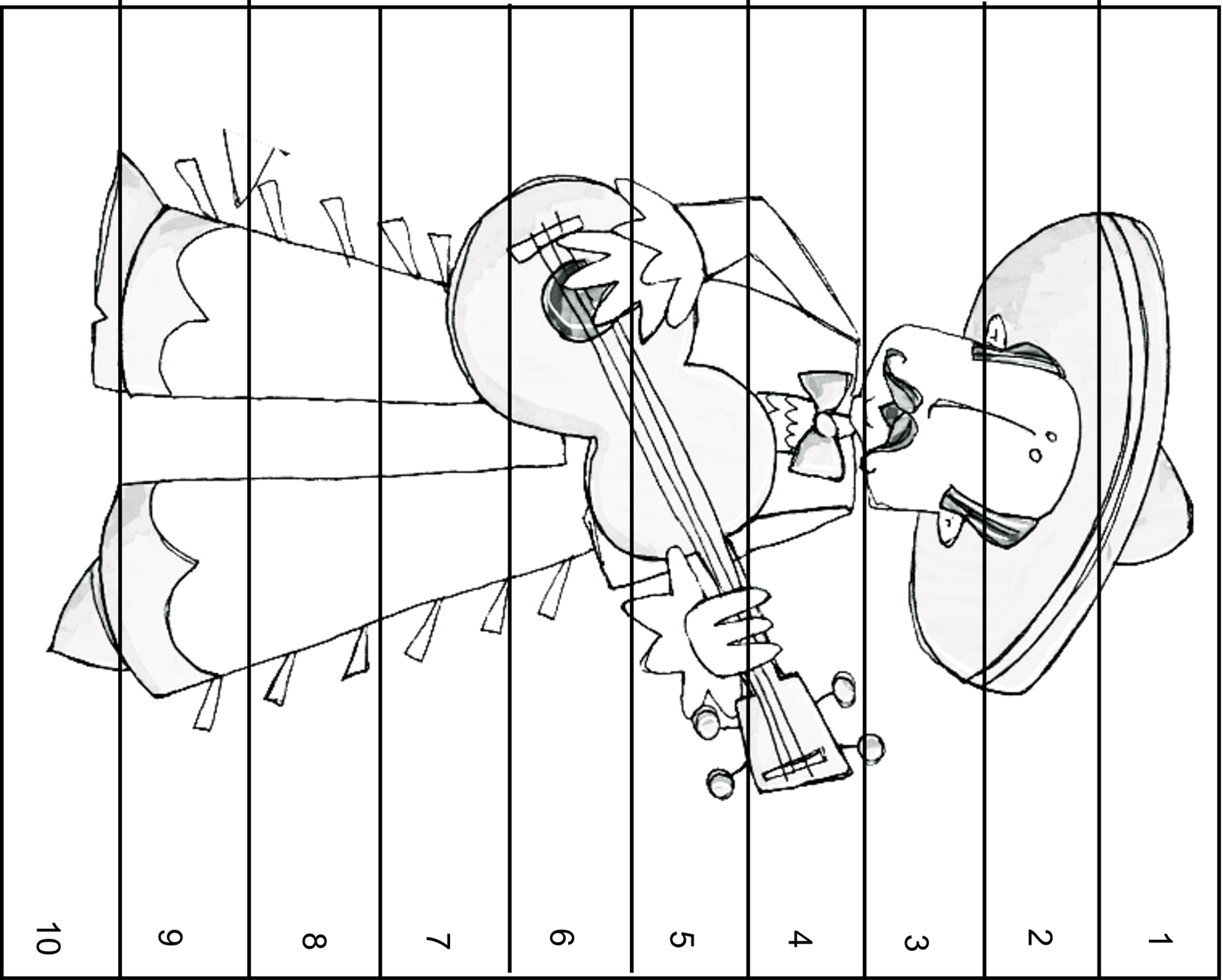

1

2

3

4

5

6

7

8

9

10

